

## Pravougaoni prigušivač buke PB-P

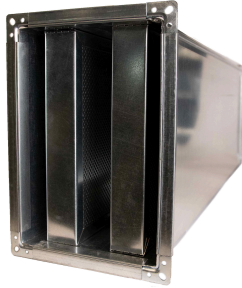

- Prigušivač buke se koristi za umanjenje buke koja nastaje u kanalskom sistemu ventilacije
- Materijal za apsorpciju zvuka je nezapaljiva mineralna staklena vuna
- Kulise obložene perf aerodinamičnog oblika, izrađene u dvije dimenzije širine  $d=100$  i  $d=200$ mm
- Spoljašnje kućište izrađeno od visokokvalitetno hladnovaljanog čeličnog pocinkovanog lima DX51D za hladno oblikovanje
- Prigušivač posjeduje priрубnice za povezivanje na sistem ventilacije na oba njegova kraja
- Tipizirane visine  $H$  ( 300, 600, 900, 1200, 1500, 1800 mm )
- Tipizirane dužine  $L$  ( 500, 1000, 1500, 2000 mm)
- Nadstrujne brzine vazduha do 20 m/s
- Radna temperatura do 100 Co

✓ Primjer označavanja **PB-P 100/100 600x900x1000**

Tip \_\_\_\_\_

Kulisa (širina/razmak)  $d/s$ (mm) \_\_\_\_\_

Dimenzije BxHxL (mm) \_\_\_\_\_

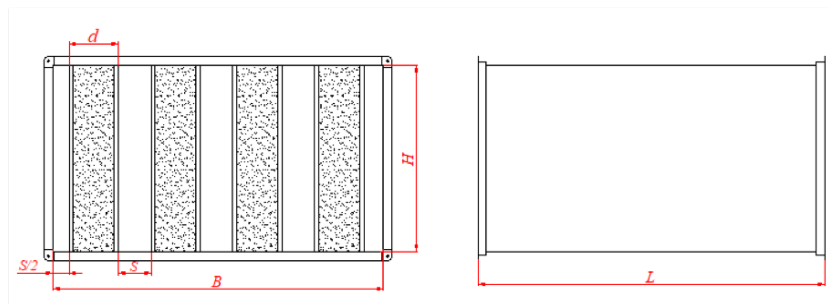

### Broj kulisa

PB-P 100/50		PB-P 100/100		PB-P 200/100		PB-P 200/200	
Širina (B)	Broj kulisa	Širina (B)	Broj kulisa	Širina (B)	Broj kulisa	Širina (B)	Broj kulisa
300	2	400	2	600	2	800	2
450	3	600	3	950	3	1300	3
600	4	800	4	1200	4	1600	4
750	5	1000	5	1500	5	2000	5
900	6	1200	6	1800	6	2400	6
1050	7	1400	7	2100	7	2800	7
1200	8	1600	8	2400	8		
1350	9	1800	9	2700	9		
1500	10						
1650	11						
1800	12						



ENPRO® je registrovana i pravno zaštićena robna marka. Sva prava zadržana.

## PB-P 100/50

H (mm)	L (mm)	PB-P 100/50 - B x H x L										
		B (mm)										
		300	450	600	750	900	1050	1200	1350	1500	1650	1800
300	500	9140554	9140578	9140602	9140626	9140650	9140674	9140700	9140724	9140749	9140773	9140797
	1000	9140555	9140579	9140603	9140627	9140651	9140676	9140701	9140725	9140750	9140774	9140798
	1500	9140556	9140580	9140604	9140628	9140652	9140677	9140702	9140726	9140751	9140775	9140799
	2000	9140557	9140581	9140605	9140629	9140653	9140678	9140703	9140727	9140752	9140776	9140800
600	500	9140558	9140582	9140606	9140630	9140654	9140679	9140704	9140728	9140753	9140777	9140801
	1000	9140559	9140583	9140607	9140631	9140655	9140680	9140705	9140729	9140754	9140778	9140802
	1500	9140560	9140584	9140608	9140632	9140656	9140681	9140706	9140730	9140755	9140779	9140803
	2000	9140561	9140585	9140609	9140633	9140657	9140682	9140707	9140731	9140756	9140780	9140804
900	500	9140562	9140586	9140610	9140634	9140658	9140683	9140708	9140732	9140757	9140781	9140805
	1000	9140563	9140587	9140611	9140635	9140659	9140684	9140709	9140733	9140758	9140782	9140806
	1500	9140564	9140588	9140612	9140636	9140660	9140685	9140710	9140734	9140759	9140783	9140807
	2000	9140565	9140589	9140613	9140637	9140661	9140686	9140711	9140735	9140760	9140784	9140808
1200	500	9140566	9140590	9140614	9140638	9140662	9140687	9140712	9140736	9140761	9140785	9140809
	1000	9140567	9140591	9140615	9140639	9140663	9140688	9140713	9140737	9140762	9140786	9140810
	1500	9140568	9140592	9140616	9140640	9140664	9140689	9140714	9140738	9140763	9140787	9140811
	2000	9140569	9140593	9140617	9140641	9140665	9140690	9140715	9140739	9140764	9140788	9140812
1500	500	9140570	9140594	9140618	9140642	9140666	9140691	9140716	9140740	9140765	9140789	9140813
	1000	9140571	9140595	9140619	9140643	9140667	9140692	9140717	9140741	9140766	9140790	9140814
	1500	9140572	9140596	9140620	9140644	9140668	9140693	9140718	9140742	9140767	9140791	9140815
	2000	9140573	9140597	9140621	9140645	9140669	9140694	9140719	9140743	9140768	9140792	9140816
1800	500	9140574	9140598	9140622	9140646	9140670	9140695	9140720	9140744	9140769	9140793	9140817
	1000	9140575	9140599	9140623	9140647	9140671	9140697	9140721	9140745	9140770	9140794	9140818
	1500	9140576	9140600	9140624	9140648	9140672	9140698	9140722	9140746	9140771	9140795	9140819
	2000	9140577	9140601	9140625	9140649	9140673	9140699	9140723	9140747	9140772	9140796	9140820



ENPRO® je registrovana i pravno zaštićena robna marka. Sva prava zadržana.

## Dijagram izbora poprečnog presjeka i otpora za PB-P 100/50

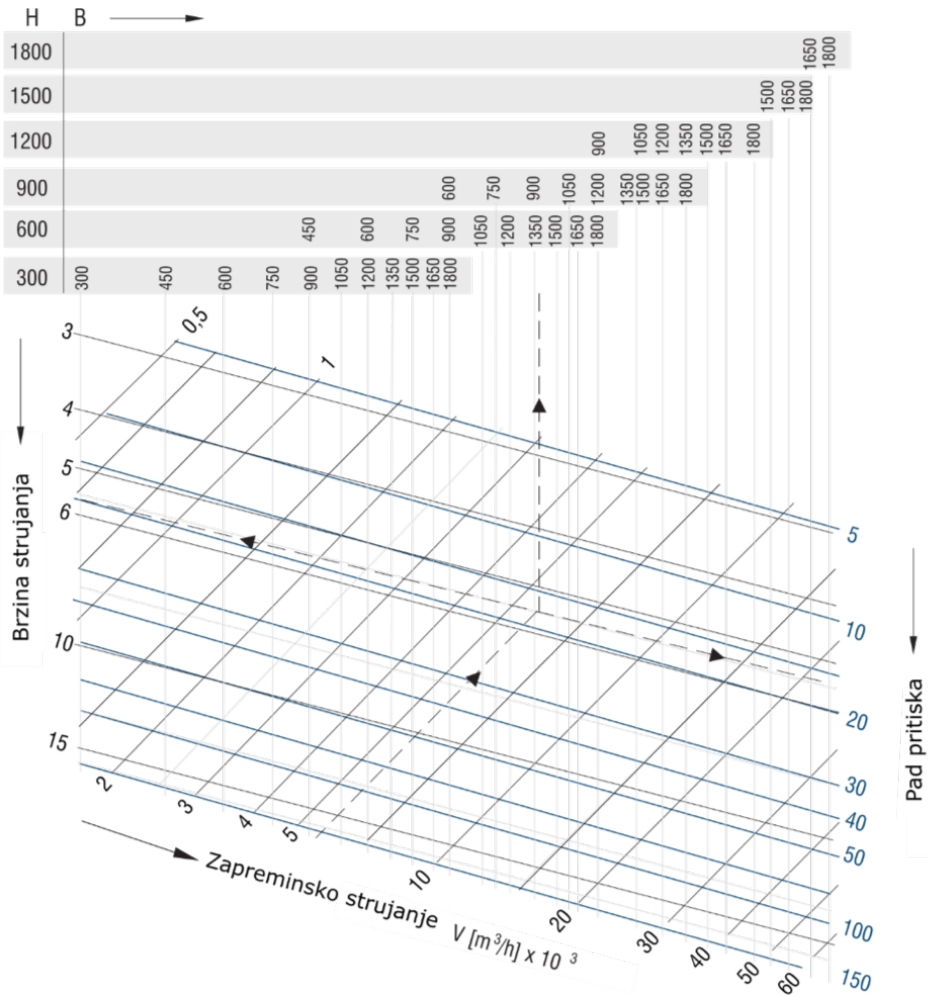

## Dijagram prigušenja za PB-P 100/50

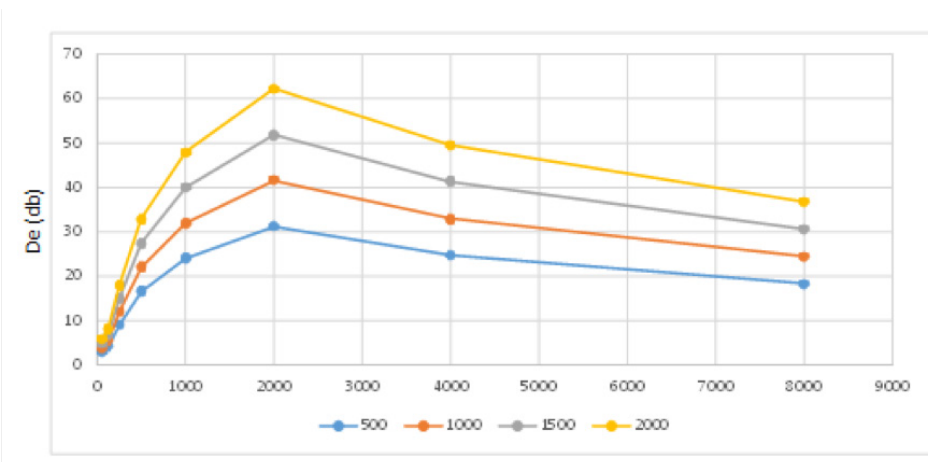

ENPRO® je registrovana i pravno zaštićena robna marka. Sva prava zadržana.

## PB-P 100/100

H (mm)	L (mm)	PBP-100/100 - B x H x L							
		B (mm)							
		400	600	800	1000	1200	1400	1600	1800
300	500	9140821	9140857	9140882	9140906	9140931	9140955	9140979	91401003
	1000	9140822	9140858	9140883	9140907	9140932	9140956	9140980	91401004
	1500	9140823	9140859	9140884	9140908	9140933	9140957	9140981	91401005
	2000	9140824	9140860	9140885	9140909	9140934	9140958	9140982	91401006
600	500	9140825	9140861	9140886	9140910	9140935	9140959	9140983	91401007
	1000	9140826	9140862	9140887	9140911	9140936	9140960	9140984	91401008
	1500	9140827	9140863	9140888	9140912	9140937	9140961	9140985	91401009
	2000	9140828	9140864	9140889	9140913	9140938	9140962	9140986	91401010
900	500	9140829	9140865	9140890	9140914	9140939	9140963	9140987	91401011
	1000	9140830	9140866	9140891	9140915	9140940	9140964	9140988	91401012
	1500	9140831	9140867	9140892	9140916	9140941	9140965	9140989	91401013
	2000	9140832	9140868	9140893	9140917	9140942	9140966	9140990	91401014
1200	500	9140833	9140869	9140894	9140918	9140943	9140967	9140991	91401015
	1000	9140834	9140870	9140895	9140919	9140944	9140968	9140992	91401016
	1500	9140835	9140871	9140896	9140920	9140945	9140969	9140993	91401017
	2000	9140836	9140873	9140897	9140921	9140946	9140970	9140994	91401018
1500	500	9140837	9140874	9140898	9140922	9140947	9140971	9140995	91401019
	1000	9140838	9140875	9140899	9140923	9140948	9140972	9140996	91401020
	1500	9140839	9140876	9140900	9140924	9140949	9140973	9140997	91401021
	2000	9140840	9140877	9140901	9140926	9140950	9140974	9140998	91401022
1800	500	9140841	9140878	9140902	9140927	9140951	9140975	9140999	91401023
	1000	9140842	9140879	9140903	9140928	9140952	9140976	9141000	91401024
	1500	9140843	9140880	9140904	9140929	9140953	9140977	9141001	91401025
	2000	9140844	9140881	9140905	9140930	9140954	9140978	9141002	91401026



ENPRO<sup>®</sup> je registrovana i pravno zaštićena robna marka. Sva prava zadržana.

## Dijagram izbora poprečnog presjeka i otpora za PB-P 100/100

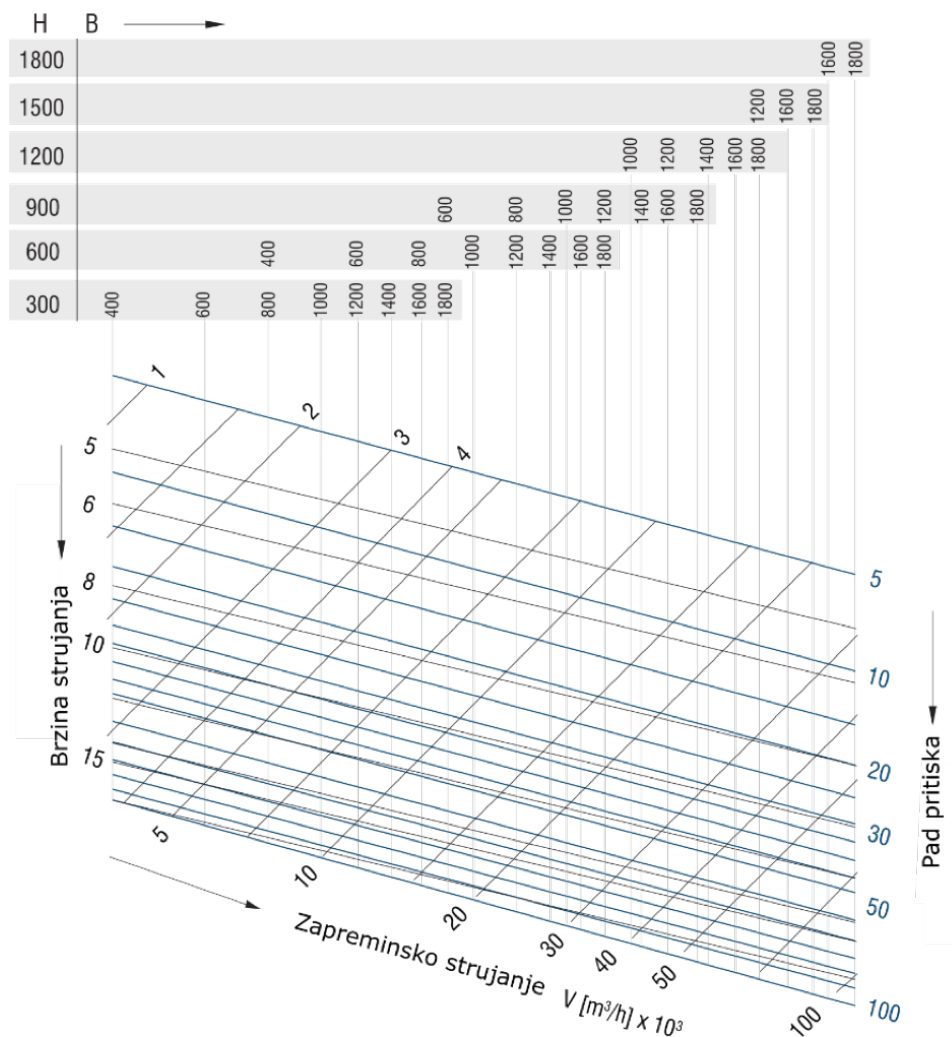

## Dijagram prigušenja za PB-P 100/100

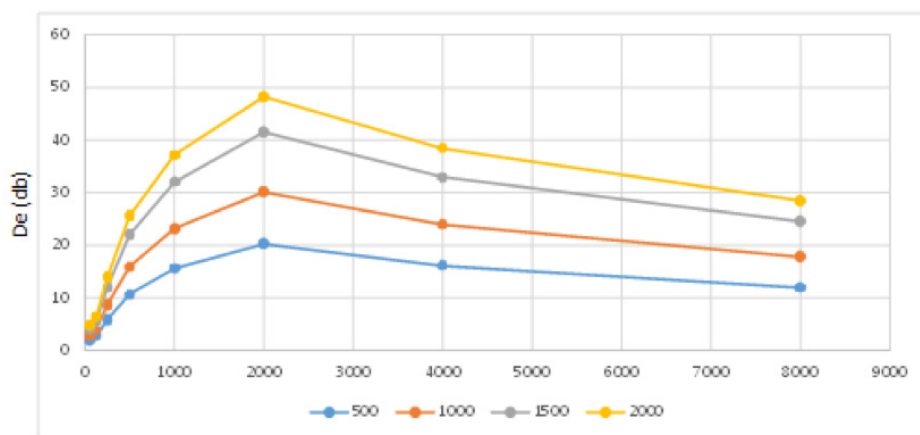

ENPRO® je registrovana i pravno zaštićena robna marka. Sva prava zadržana.

## PB-P 200/100

H mm	L mm	PBP-200/100 - B x H x L							
		B (mm)							
		600	900	1200	1500	1800	2100	2400	2700
300	500	9141027	9141052	9141076	9141103	9141129	9141153	9141178	9141202
	1000	9141028	9141053	9141078	9141104	9141130	9141154	9141179	9141203
	1500	9141029	9141054	9141079	9141106	9141131	9141155	9141180	9141204
	2000	9141030	9141055	9141080	9141107	9141132	9141156	9141181	9141205
600	500	9141031	9141056	9141081	9141108	9141133	9141157	9141182	9141206
	1000	9141032	9141057	9141082	9141109	9141134	9141158	9141183	9141207
	1500	9141033	9141058	9141083	9141110	9141135	9141160	9141184	9141208
	2000	9141034	9141059	9141084	9141111	9141136	9141161	9141185	9141209
900	500	9141035	9141060	9141085	9141112	9141137	9141162	9141186	9141210
	1000	9141036	9141061	9141086	9141113	9141138	9141163	9141187	9141211
	1500	9141037	9141062	9141087	9141114	9141139	9141164	9141188	9141212
	2000	9141038	9141063	9141088	9141115	9141140	9141165	9141189	9141213
1200	500	9141039	9141064	9141089	9141116	9141141	9141166	9141190	9141214
	1000	9141040	9141065	9141090	9141117	9141142	9141167	9141191	9141215
	1500	9141041	9141066	9141091	9141118	9141143	9141168	9141192	9141216
	2000	9141042	9141067	9141092	9141119	9141144	9141169	9141193	9141217
1500	500	9141043	9141068	9141093	9141120	9141145	9141170	9141194	9141218
	1000	9141044	9141069	9141094	9141121	9141146	9141171	9141195	9141219
	1500	9141045	9141070	9141095	9141122	9141147	9141172	9141196	9141220
	2000	9141046	9141071	9141096	9141124	9141148	9141173	9141197	9141221
1800	500	9141047	9141072	9141097	9141125	9141149	9141174	9141198	9141222
	1000	9141048	9141073	9141098	9141126	9141150	9141175	9141199	9141223
	1500	9141049	9141074	9141099	9141127	9141151	9141176	9141200	9141224
	2000	9141050	9141075	9141100	9141128	9141152	9141177	9141201	9141225



ENPRO® je registrovana i pravno zaštićena robna marka. Sva prava zadržana.

## Dijagram izbora poprečnog presjeka i otpora za PB-P 200/100

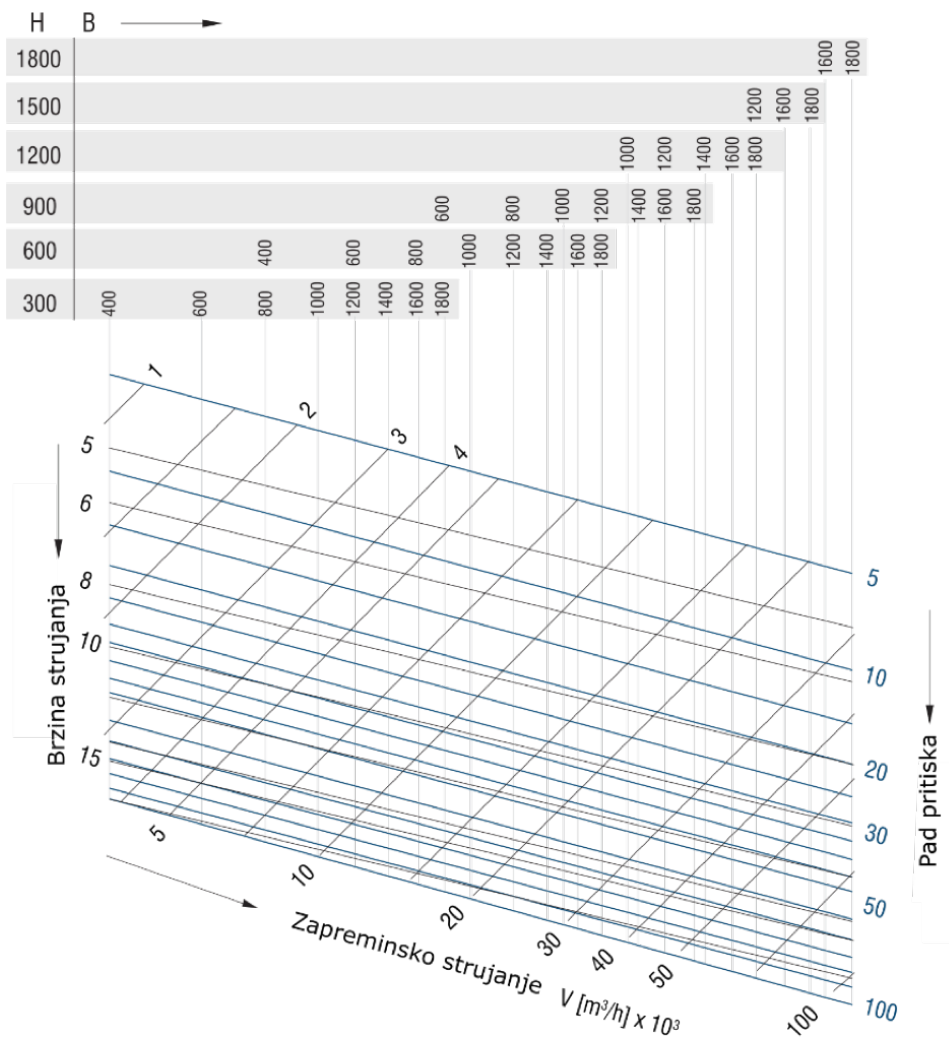

## Dijagram prigušenja za PB-P 200/100

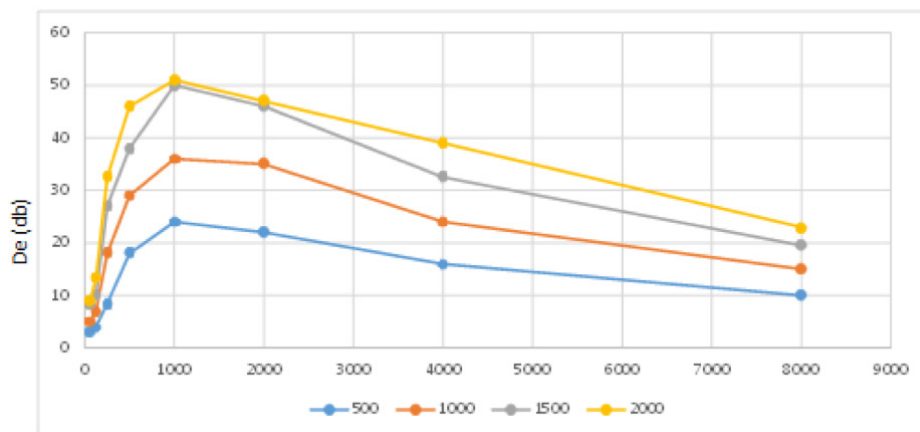

ENPRO® je registrovana i pravno zaštićena robna marka. Sva prava zadržana.

## PB-P 200/200

H mm	L mm	PBP-200/200 - B x H x L					
		B (mm)					
		800	1200	1600	2000	2400	2800
300	500	9141226	9141250	9141274	9141298	9141322	9141346
	1000	9141227	9141251	9141275	9141299	9141323	9141347
	1500	9141228	9141252	9141276	9141300	9141324	9141348
	2000	9141229	9141253	9141277	9141301	9141325	9141349
600	500	9141230	9141254	9141278	9141302	9141326	9141350
	1000	9141231	9141255	9141279	9141303	9141327	9141351
	1500	9141232	9141256	9141280	9141304	9141328	9141352
	2000	9141233	9141257	9141281	9141305	9141329	9141353
900	500	9141234	9141258	9141282	9141306	9141330	9141354
	1000	9141235	9141259	9141283	9141307	9141331	9141355
	1500	9141236	9141260	9141284	9141308	9141332	9141356
	2000	9141237	9141261	9141285	9141309	9141333	9141357
1200	500	9141238	9141262	9141286	9141310	9141334	9141358
	1000	9141239	9141263	9141287	9141311	9141335	9141359
	1500	9141240	9141264	9141288	9141312	9141336	9141360
	2000	9141241	9141265	9141289	9141313	9141337	9141361
1500	500	9141242	9141266	9141290	9141314	9141338	9141362
	1000	9141243	9141267	9141291	9141315	9141339	9141363
	1500	9141244	9141268	9141292	9141316	9141340	9141364
	2000	9141245	9141269	9141293	9141317	9141341	9141365
1800	500	9141246	9141270	9141294	9141318	9141342	9141366
	1000	9141247	9141271	9141295	9141319	9141343	9141367
	1500	9141248	9141272	9141296	9141320	9141344	9141368
	2000	9141249	9141273	9141297	9141321	9141345	9141369



ENPRO® je registrovana i pravno zaštićena robna marka. Sva prava zadržana.

## Dijagram izbora poprečnog presjeka i otpora za PB-P 200/200

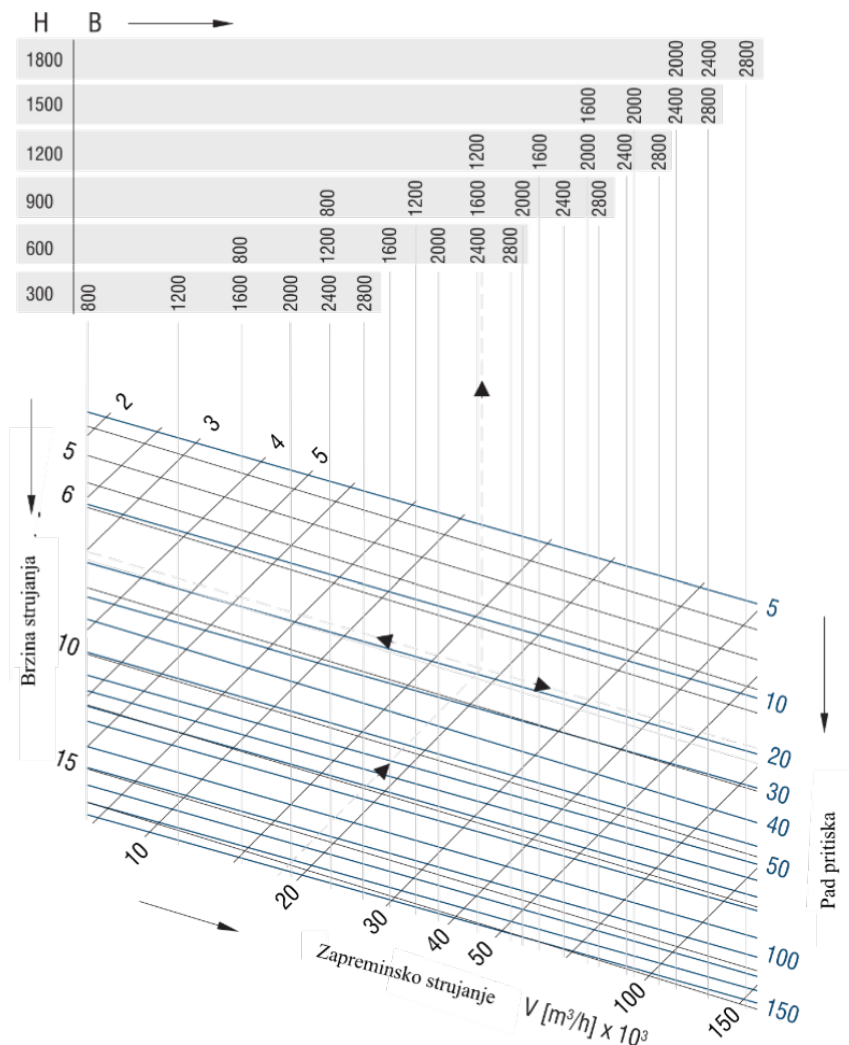

## Dijagram prigušenja, za PB-P 200/200

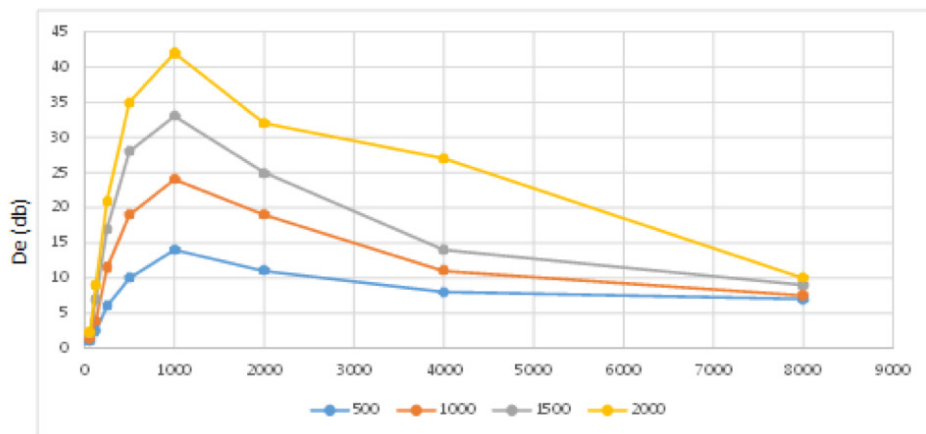

ENPRO® je registrovana i pravno zaštićena robna marka. Sva prava zadržana.